



UNIVERSITY OF CAMBRIDGE INTERNATIONAL EXAMINATIONS
International General Certificate of Secondary Education

PHYSICS

0625/01

Paper 1 Multiple Choice

October/November 2008

45 minutes

Additional Materials: Multiple Choice Answer Sheet
Soft clean eraser
Soft pencil (type B or HB recommended)



READ THESE INSTRUCTIONS FIRST

Write in soft pencil.

Do not use staples, paper clips, highlighters, glue or correction fluid.

Write your name, Centre number and candidate number on the Answer Sheet in the spaces provided unless this has been done for you.

There are **forty** questions on this paper. Answer **all** questions. For each question there are four possible answers **A, B, C** and **D**.

Choose the **one** you consider correct and record your choice in **soft pencil** on the separate Answer Sheet.

Read the instructions on the Answer Sheet very carefully.

Each correct answer will score one mark. A mark will not be deducted for a wrong answer.
Any rough working should be done in this booklet.

This document consists of **20** printed pages.



- 1 Two digital stopwatches X and Y, which record in minutes and seconds, are used to time a race. The readings of the two stopwatches, at the start and at the end of the race, are shown.

	start	end
stopwatch X	00:00	00:40

	start	end
stopwatch Y	01:30	02:20

Which statement about the time of the race is correct?

- A** Both stopwatches record the same time interval.
 - B** Stopwatch X recorded 10 s longer than stopwatch Y.
 - C** Stopwatch Y recorded 10 s longer than stopwatch X.
 - D** Stopwatch Y recorded 50 s longer than stopwatch X.
- 2 A tennis player hits a ball over the net.

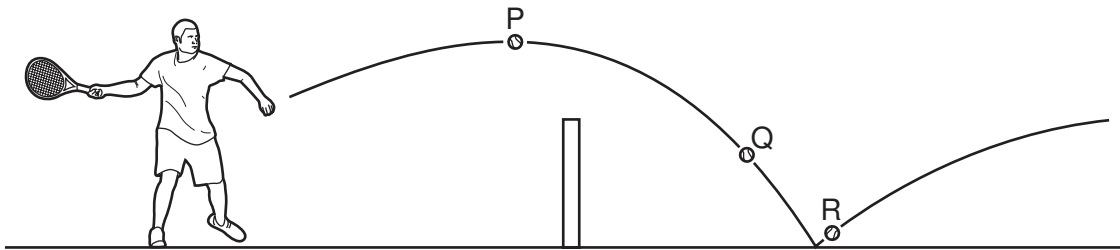

In which position is the ball accelerating?

- A** P and Q only
- B** P and R only
- C** Q and R only
- D** P, Q and R

- 3 A car travels at various speeds during a short journey.

The table shows the distances travelled and the time taken during each of four stages P, Q, R and S.

stage	P	Q	R	S
distance travelled / km	1.8	3.6	2.7	2.7
time taken / minutes	2	2	4	3

During which two stages is the car travelling at the same speed?

- A P and Q B P and S C Q and R D R and S
- 4 What is the meaning of the *weight* of an object?
- A the density of the material from which it is made
 B the force exerted on it by gravity
 C the mass of the matter it contains
 D the pressure it exerts on the floor
- 5 The weight of an object is to be found using the beam balance shown in the diagram.

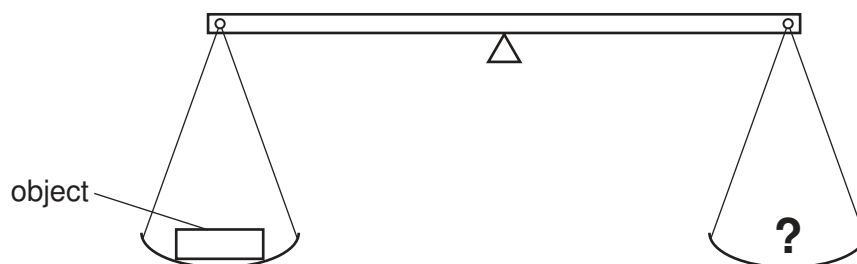

The object is put in the left-hand pan and various standard weights are put in the right-hand pan, with the following results.

weights in the right hand pan	effect
0.1 N, 0.1 N, 0.05 N, 0.02 N	balance tips down slightly on the left-hand side
0.2 N, 0.1 N, 0.01 N	balance tips down slightly on the right-hand side

What is the best estimate of the weight of the object?

- A 0.27 N B 0.29 N C 0.31 N D 0.58 N

6 A student needs to find the density of a cubic block of wood.

Which two pieces of apparatus should she use?

- A balance and metre rule
- B balance and thermometer
- C measuring cylinder and metre rule
- D measuring cylinder and thermometer

7 Two identical measuring cylinders containing different liquids are placed on a simple balance.

They balance as shown.

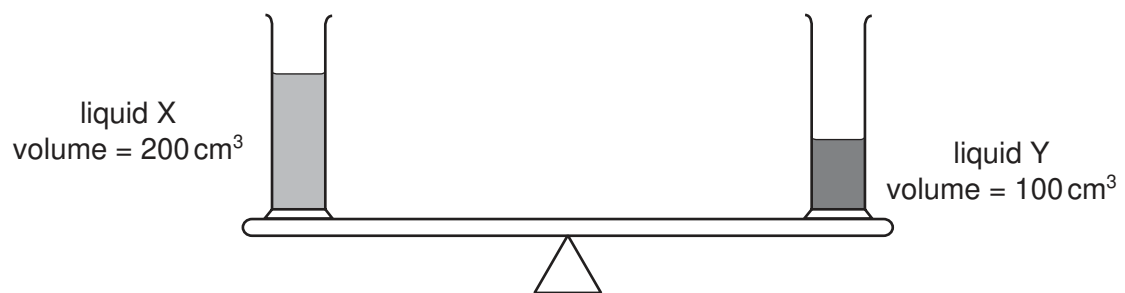

How does the density of X compare with the density of Y?

- A density of X = $\frac{1}{2}$ × density of Y
- B density of X = density of Y
- C density of X = 2 × density of Y
- D density of X = 4 × density of Y

- 8 The diagrams show a uniform rod with its midpoint on a pivot.

Two equal forces F are applied to the rod, as shown.

Which diagram shows the rod in equilibrium?

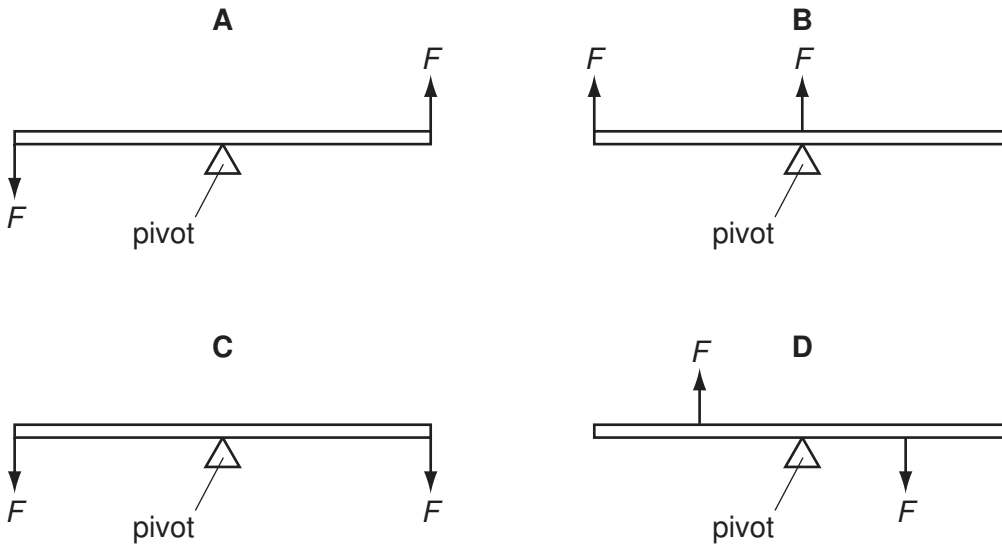

- 9 A train is travelling along a horizontal track at constant speed. Two of the forces acting on the train are shown in the diagram.

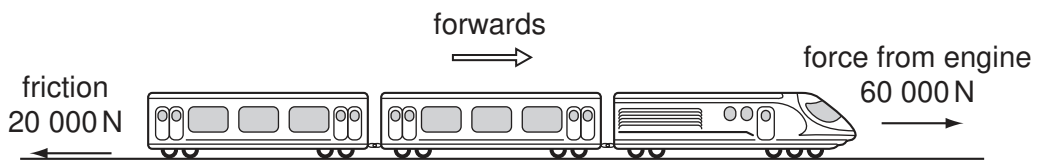

A force of air resistance is also acting on the train to give it a resultant force of zero.

What is this air resistance force?

- A 40 000 N backwards
- B 80 000 N backwards
- C 40 000 N forwards
- D 80 000 N forwards

10 The diagram shows water stored behind a dam.

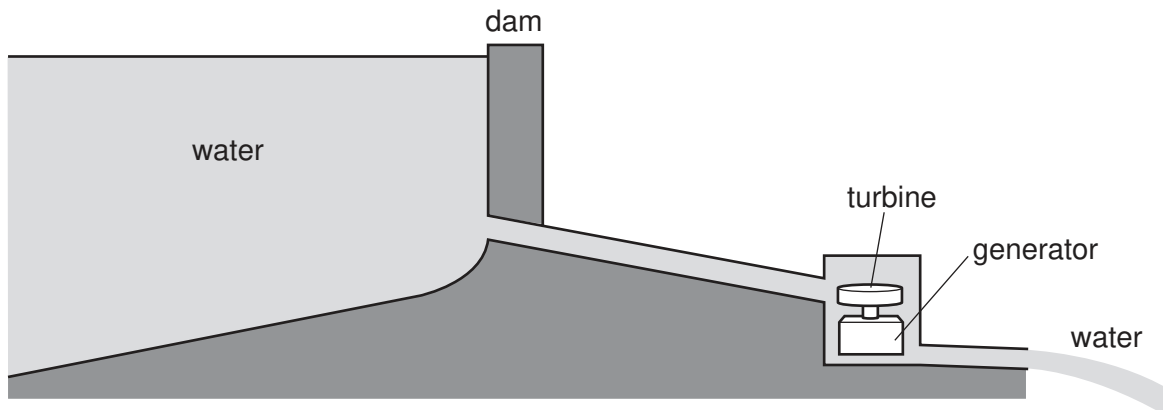

The water flows to a turbine and turns a generator.

Which sequence for the conversion of energy is correct?

- A gravitational energy → kinetic energy → electrical energy
 - B kinetic energy → gravitational energy → electrical energy
 - C gravitational energy → electrical energy → kinetic energy
 - D kinetic energy → electrical energy → gravitational energy
- 11 A rubber ball is dropped from a height of 2 m on to a table.

Whilst in contact with the table, some of its energy is converted into internal energy.

What is the highest possible point the ball could reach after bouncing?

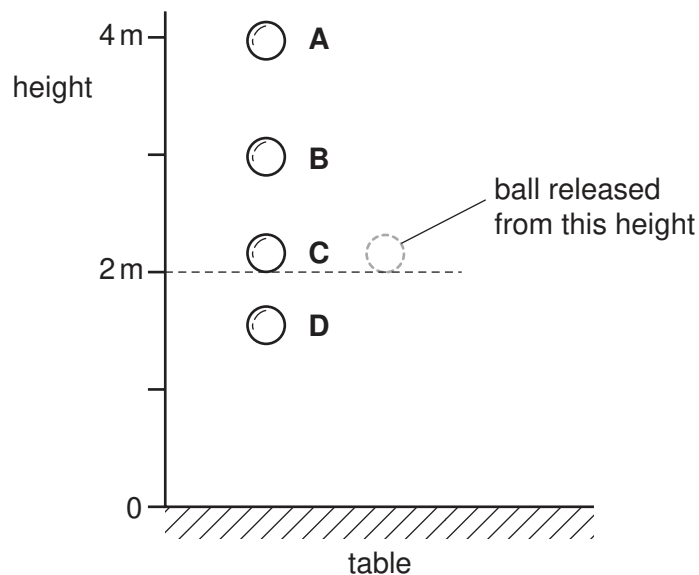

12 The diagram shows a simple mercury barometer used to measure atmospheric pressure.

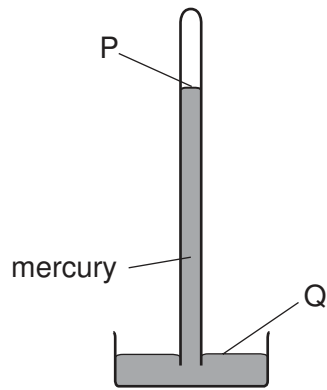

Which statement is correct?

- A The pressure at P is atmospheric pressure.
- B The pressure at P is nearly zero.
- C The pressure at Q is lower than the pressure at P.
- D The pressure at Q is nearly zero.

- 13 A brick with rectangular sides rests on a table.

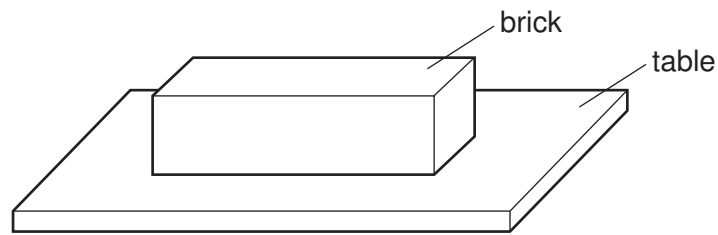

The brick is now turned so that it rests on the table on its smallest face.

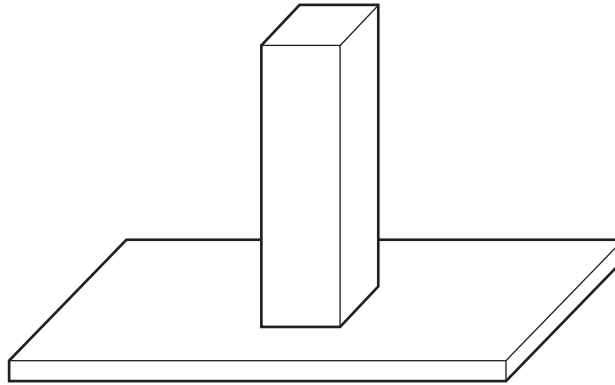

How has this change affected the force and the pressure exerted by the brick on the table?

	force	pressure
A	unchanged	unchanged
B	increased	unchanged
C	unchanged	increased
D	increased	increased

- 14 Viewed through a microscope, very small particles can be seen moving with Brownian motion.

Which line in the table is correct?

	type of motion of particles	particles are suspended in
A	vibration	a liquid or a gas
B	vibration	a solid, a liquid or a gas
C	random	a liquid or a gas
D	random	a solid, a liquid or a gas

- 15 The pressure of a fixed mass of gas in a cylinder is measured. The volume of the gas in the cylinder is then slowly decreased.

Which graph could show the change of pressure of the gas during this process?

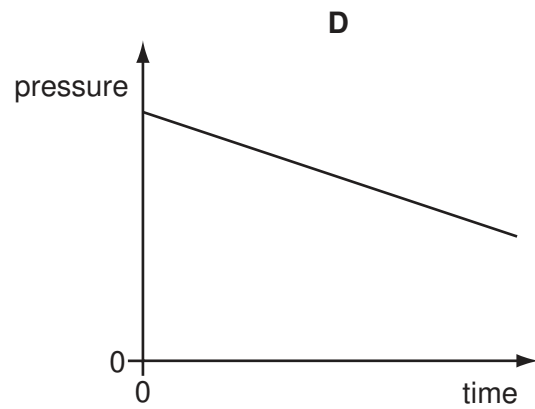
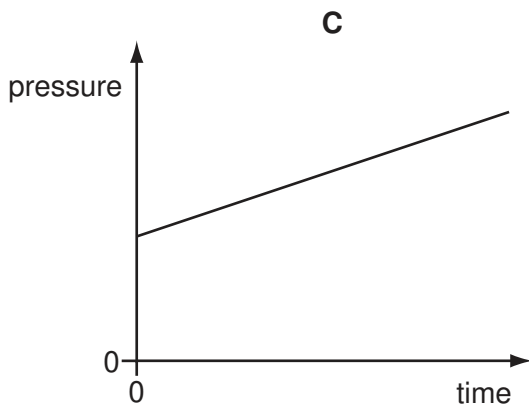
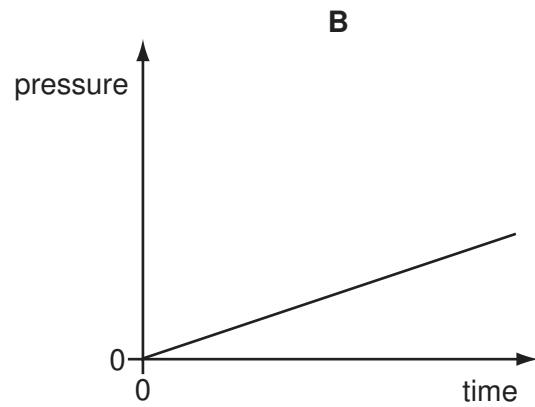
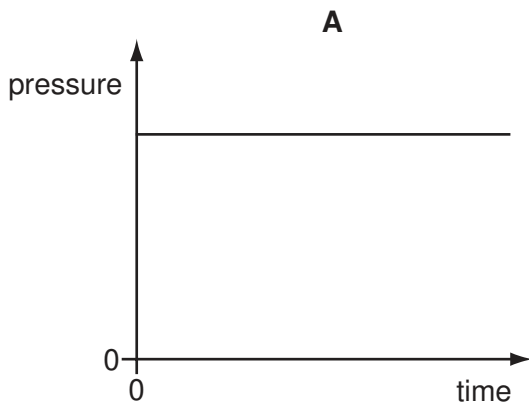

- 16 Equal masses of two different liquids are heated using the same heater. The graph shows how the temperature of each liquid changes with time.

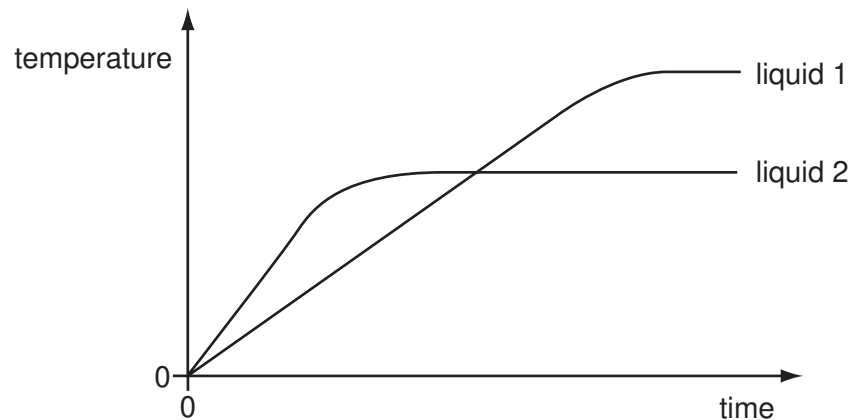

What does the graph tell us about the liquids?

- A Liquid 1 has a higher melting point than liquid 2.
 - B Liquid 1 has a higher boiling point than liquid 2.
 - C Liquid 1 starts to melt sooner than liquid 2.
 - D Liquid 1 starts to boil sooner than liquid 2.
- 17 An engineer wants to fix a steel washer on to a steel rod. The rod is just too big to fit into the hole of the washer.

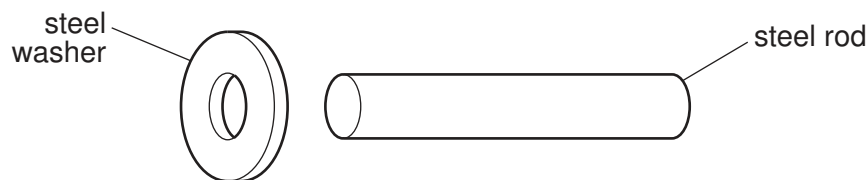

How can the engineer fit the washer on to the rod?

- A Cool the washer and put it over the rod.
- B Cool the washer and rod to the same temperature and push them together.
- C Heat the rod and then place it in the hole.
- D Heat the washer and then place it over the rod.

- 18 A cup with a lid contains a hot drink.

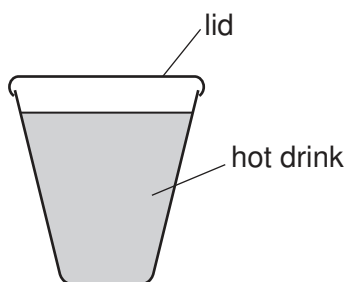

When the lid is removed, the rate of heat loss from the drink increases.

What causes this?

- A convection only
 - B evaporation only
 - C both convection and evaporation
 - D neither convection nor evaporation
- 19 A cupboard is placed in front of a heater. Air can move through a gap under the cupboard.

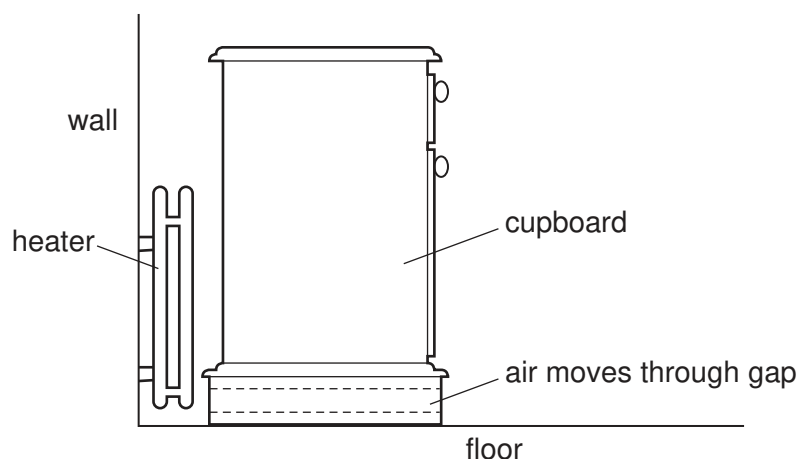

Which line in the table describes the temperature and the direction of the air that moves through the gap?

	air temperature	air direction
A	cool	away from the heater
B	cool	towards the heater
C	warm	away from the heater
D	warm	towards the heater

20 Waves in a tank pass from shallow to deep water.

The wavefront diagram is shown.

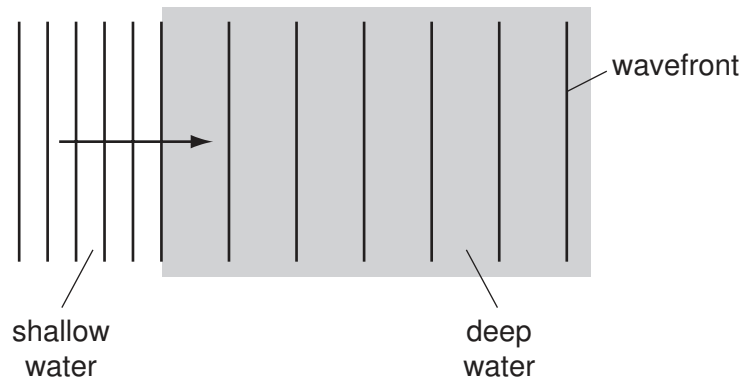

Which quantity increases as the waves enter the deep water?

- A amplitude
- B frequency
- C wave energy
- D wavelength

21 The diagrams represent water waves in a tank.

Which diagram represents waves that change speed?

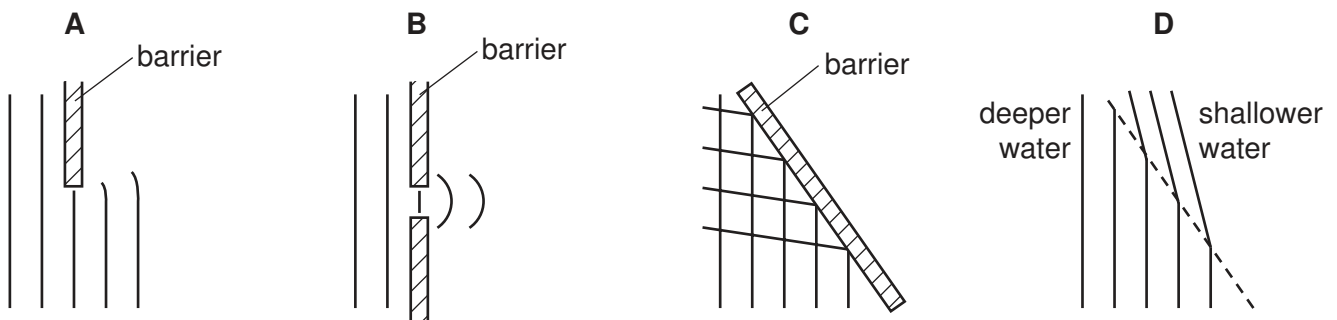

22 Which diagram shows the dispersion of white light?

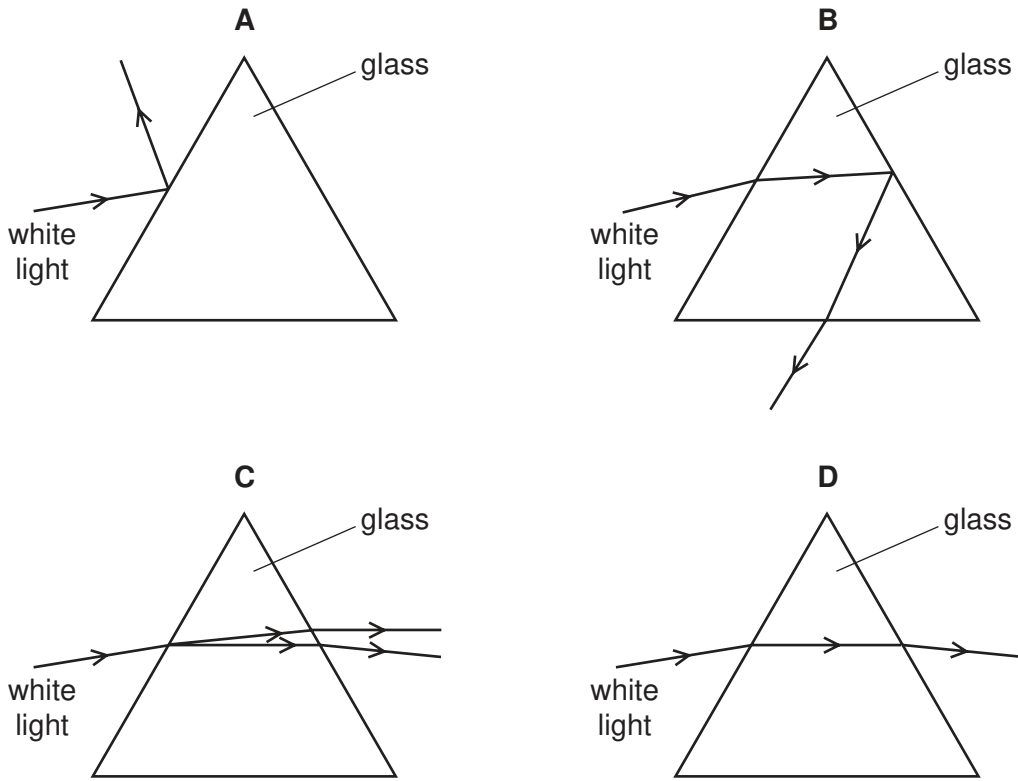

23 In the diagram, the distance OP is the focal length of the lens.

Through which point will the ray shown pass, after refraction by the lens?

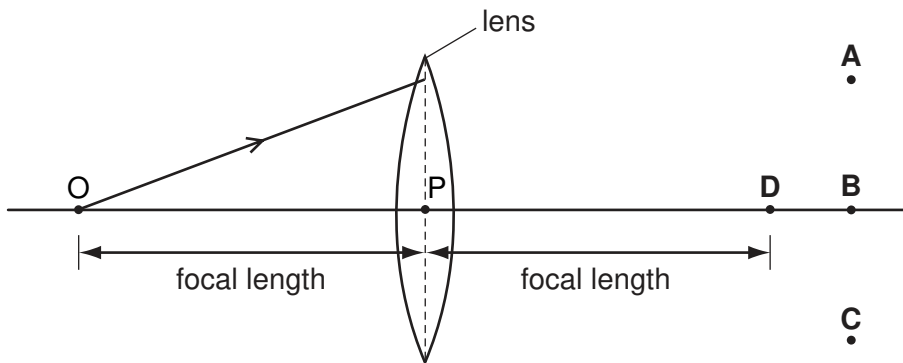

24 Which word correctly completes the sentence below?

An echo is a sound wave which is by a large obstacle.

- A absorbed
- B dispersed
- C reflected
- D refracted

- 25 In an experiment to measure the speed of sound, a student uses a stopwatch to find how long a sound takes to travel from X to Y. She does this six times.

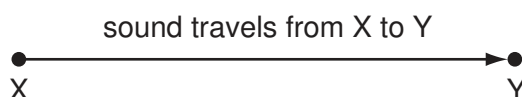

The table shows her results.

	time / s
first	0.5
second	0.7
third	0.6
fourth	0.4
fifth	0.9
sixth	0.5

What value for the time should be used to calculate the speed of sound?

- A** 0.4 s **B** 0.5 s **C** 0.6 s **D** 0.9 s
- 26 A student wishes to demagnetise a steel bar. He uses the apparatus shown.

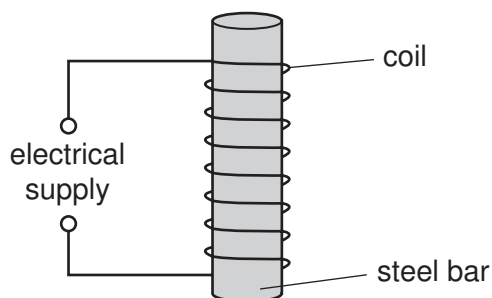

Which type of electrical supply should the student use and what should he do with the steel bar?

	supply	what to do with the steel bar
A	a.c.	keep it inside the coil
B	a.c.	slowly remove it from the coil
C	d.c.	keep it inside the coil
D	d.c.	slowly remove it from the coil

- 27 Two metal bars are held together. At least one of the bars is a magnet. The bars repel each other.

What does this show about the bars and why?

	what it shows	why
A	only one of the bars is a magnet	two magnets always attract each other
B	only one of the bars is a magnet	induced magnetism in the other bar makes it repel
C	they are both magnets	there must be like poles facing each other
D	they are both magnets	there must be opposite poles facing each other

- 28 When there is an electric current in a metal wire, what flows through the wire?

- A** atoms
- B** electrons
- C** neutrons
- D** protons

- 29 The table shows the voltage and current ratings for four electric heaters.

Which heater has the least resistance?

	voltage / V	current / A
A	110	5.0
B	110	10.0
C	230	5.0
D	230	10.0

30 In the circuit below, X and Y are identical 6 V lamps.

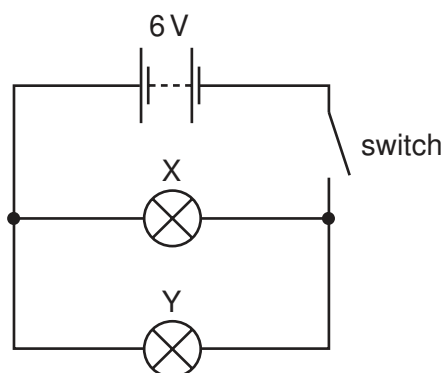

What happens when the switch is closed (the current is switched on)?

- A X lights more brightly than Y.
- B Y lights more brightly than X.
- C X and Y both light with full brightness.
- D X and Y both light with half brightness.

31 The diagram shows four different circuits.

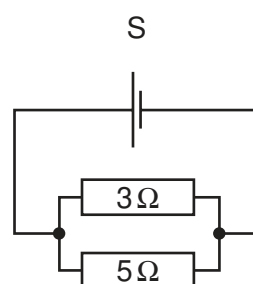
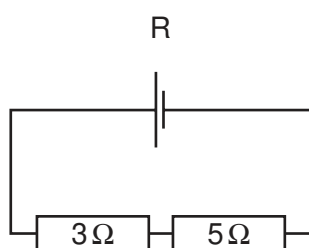
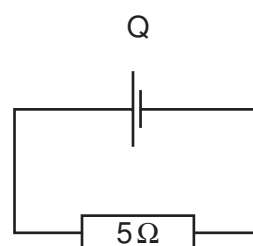
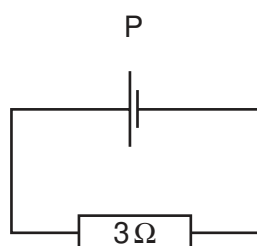

What is the order of increasing resistance of these circuits?

	lowest resistance	→	highest resistance
A	P	Q	R S
B	R	S	P Q
C	S	P	Q R
D	P	R	Q S

32 A student makes four circuits.

In which circuit are both lamps protected by the fuse?

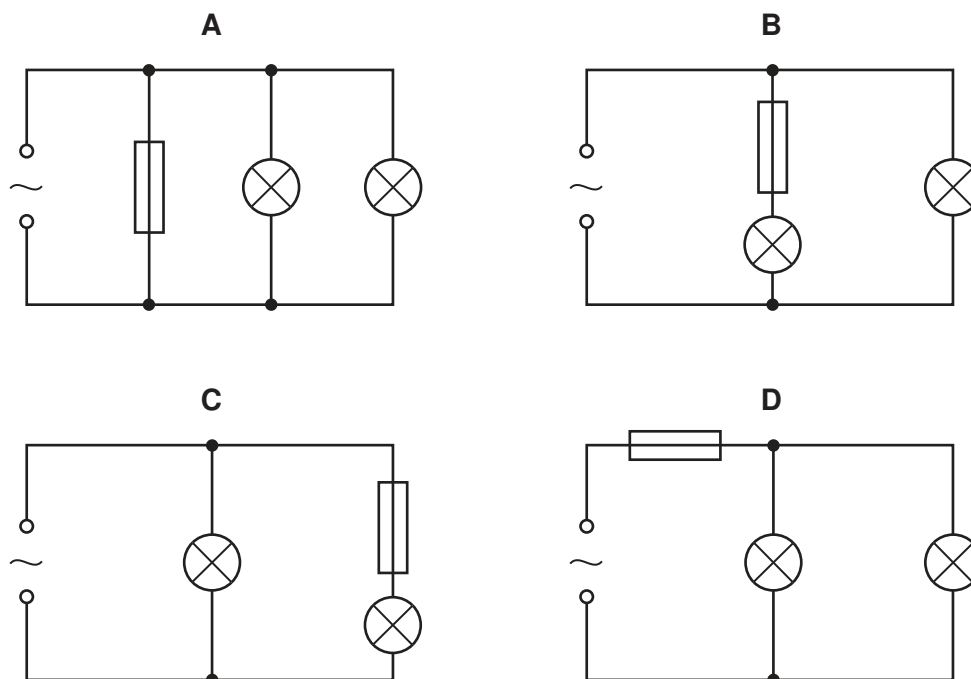

33 A mains circuit can safely supply a current of 40 A.

A hairdryer takes 2 A. It is connected to the circuit by a lead which can safely carry up to 5 A.

Which fuse is best to use in the plug fitted to the hairdryer lead?

- A** 1 A fuse **B** 3 A fuse **C** 10 A fuse **D** 50 A fuse

34 Two different systems are used to transmit equal amounts of electrical power from one building to another.

One system uses low voltage and the other uses high voltage. Both systems use identical wires.

Which line in the table is correct about which system wastes least energy and why?

	least energy wasted	why
A	high voltage system	the current in the wires is bigger
B	high voltage system	the current in the wires is smaller
C	low voltage system	the current in the wires is bigger
D	low voltage system	the current in the wires is smaller

- 35 When the electric current in wire XY is in the direction shown, there is an upward force on the wire.

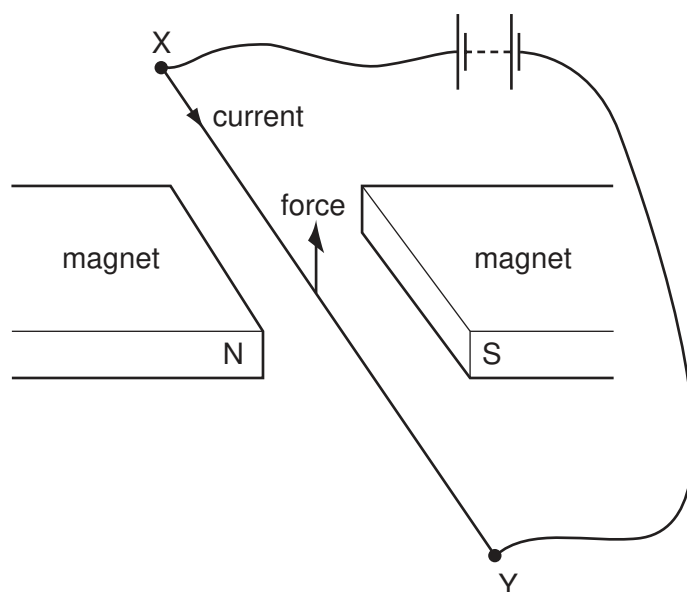

If the north and south poles of the magnet exchange positions, in which direction will the force on the wire act?

- A downwards
 - B upwards
 - C to the left
 - D to the right
- 36 A cathode-ray beam passes through an electric field between charged parallel plates.

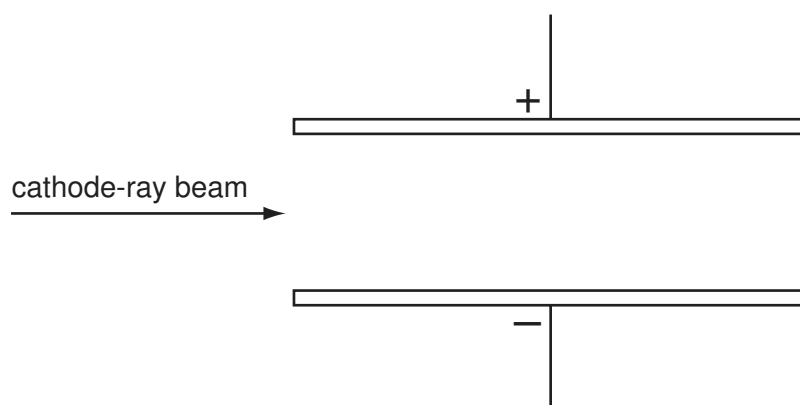

In which direction is the beam deflected?

- A towards the negative plate
- B towards the positive plate
- C into the page
- D out of the page

37 When the thermistor in the circuit below is heated, the lamp becomes brighter.

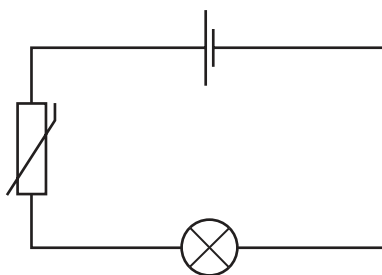

Why does this happen?

- A The resistance of the lamp decreases.
 - B The resistance of the lamp increases.
 - C The resistance of the thermistor decreases.
 - D The resistance of the thermistor increases.
- 38 The diagram shows an experiment to monitor the radiation from a radioactive gas. The counter readings are corrected for background radiation.

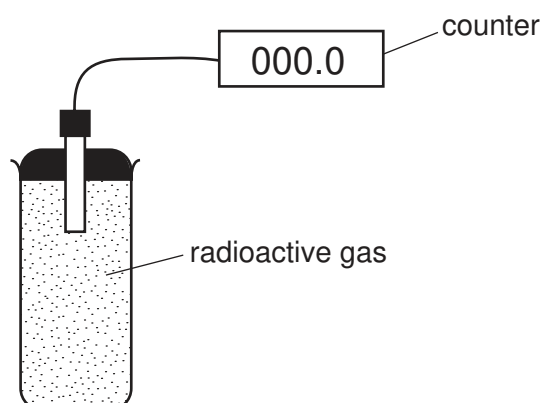

The table shows how the counter reading varies with time.

time / seconds	0	20	40	60	80	100	120	140	160	180
counter reading / counts per minute	140	105	82	61	44	36	27	20	15	10

What is the half-life of the gas?

- A between 20 and 40 seconds
- B between 40 and 60 seconds
- C between 60 and 140 seconds
- D between 140 and 180 seconds

39 Which material is commonly used as a lining for a box for storing radioactive samples?

- A aluminium
- B copper
- C lead
- D uranium

40 A uranium ${}_{92}^{238}\text{U}$ nucleus emits an α -particle.

What are the new nucleon and proton numbers?

	nucleon number	proton number
A	238	88
B	236	90
C	234	92
D	234	90

Permission to reproduce items where third-party owned material protected by copyright is included has been sought and cleared where possible. Every reasonable effort has been made by the publisher (UCLES) to trace copyright holders, but if any items requiring clearance have unwittingly been included, the publisher will be pleased to make amends at the earliest possible opportunity.

University of Cambridge International Examinations is part of the Cambridge Assessment Group. Cambridge Assessment is the brand name of University of Cambridge Local Examinations Syndicate (UCLES), which is itself a department of the University of Cambridge.